

SURFACE

Push-button



DJ00010F
Bright finish



DJ0020F
Satin finish

General Description

- Wall mounted liquid soap dispenser of 1.1 L capacity, manufactured in thermoplastic ABS, 3 mm thick, to be installed directly on the wall and hand-operated by means of a push-button.
- Available in two finishes (white or black smoked) these soap dispenser models have a functional and trendy design that matches the new range of Mediclinics bathroom accessories. This allows this soap dispenser to blend into any space perfectly.
- Suitable for high traffic facilities and for public use.
- Robust and vandal-resistant.
- It is recommended to use liquid soap or hand sanitizing gel with the following characteristics:
 - Maximum alcohol content of 80%
 - Density between 0.9 and 1.35 kg/dm³
 - Viscosity between 500 and 2,500 cps.

It does not support soaps that contain methanol, chlorine or solid or abrasive particles.
- It is mounted on the wall by means of four steel screws (provided) with their corresponding plastic plugs (also provided).

Components & materials

- **DJ0010F:** soap dispenser made of white smoke ABS.
- **DJ0020F:** soap dispenser made of black smoke ABS.
- **LID:** located on the top of the soap dispenser, it is made of ABS. To refill, the lid is opened using a standard Mediclinics key supplied.
- **PUSH-BUTTON:** made of ABS.
- **VALVE:** anti-dripping and anti-corrosion. Design based on a polyamide piston with 2 elastomeric toroidal gaskets, silicone blocking pivot and stainless steel ball to ensure tightness.
- **SPRINGS:** made of steel AISI 302.

Technical Specifications

Dimensions	204 x 107 x 108 mm
Capacity	1,100 ml
Body thickness	3.0 mm
Operable force	26 N
Net weight	0.3 Kg
Quantity dispensed per pump	1.2 ml

Dimensions

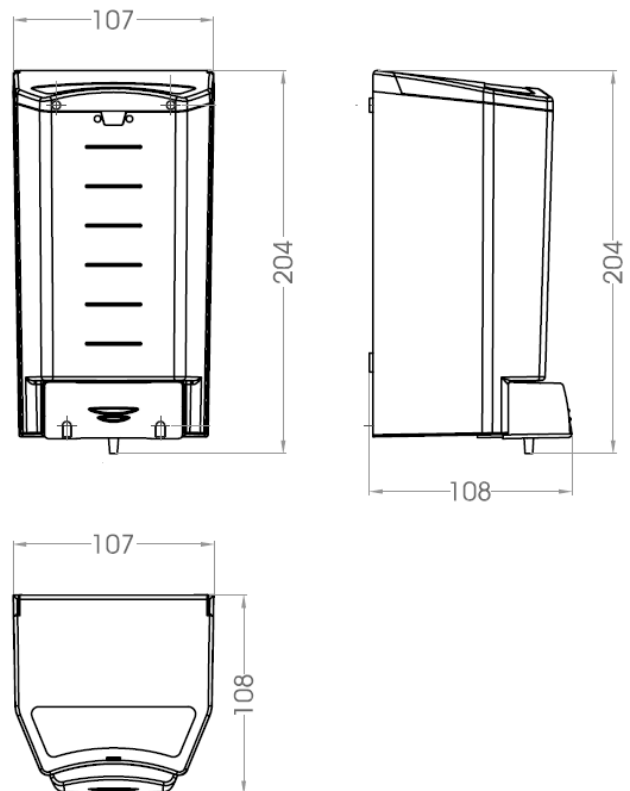

Dimensions: ±4%

OPERATION

Place one hand just under the soap dispenser valve and press the center push-button until the end of the soap dosage.

MOUNTING TEMPLATE

Fix the soap dispenser to 10-15 cm from shelf, through the holes of the wall and floor plates, using the stainless steel screws supplied and taking into account the distances of the points indicated by an "S" in the next figure:

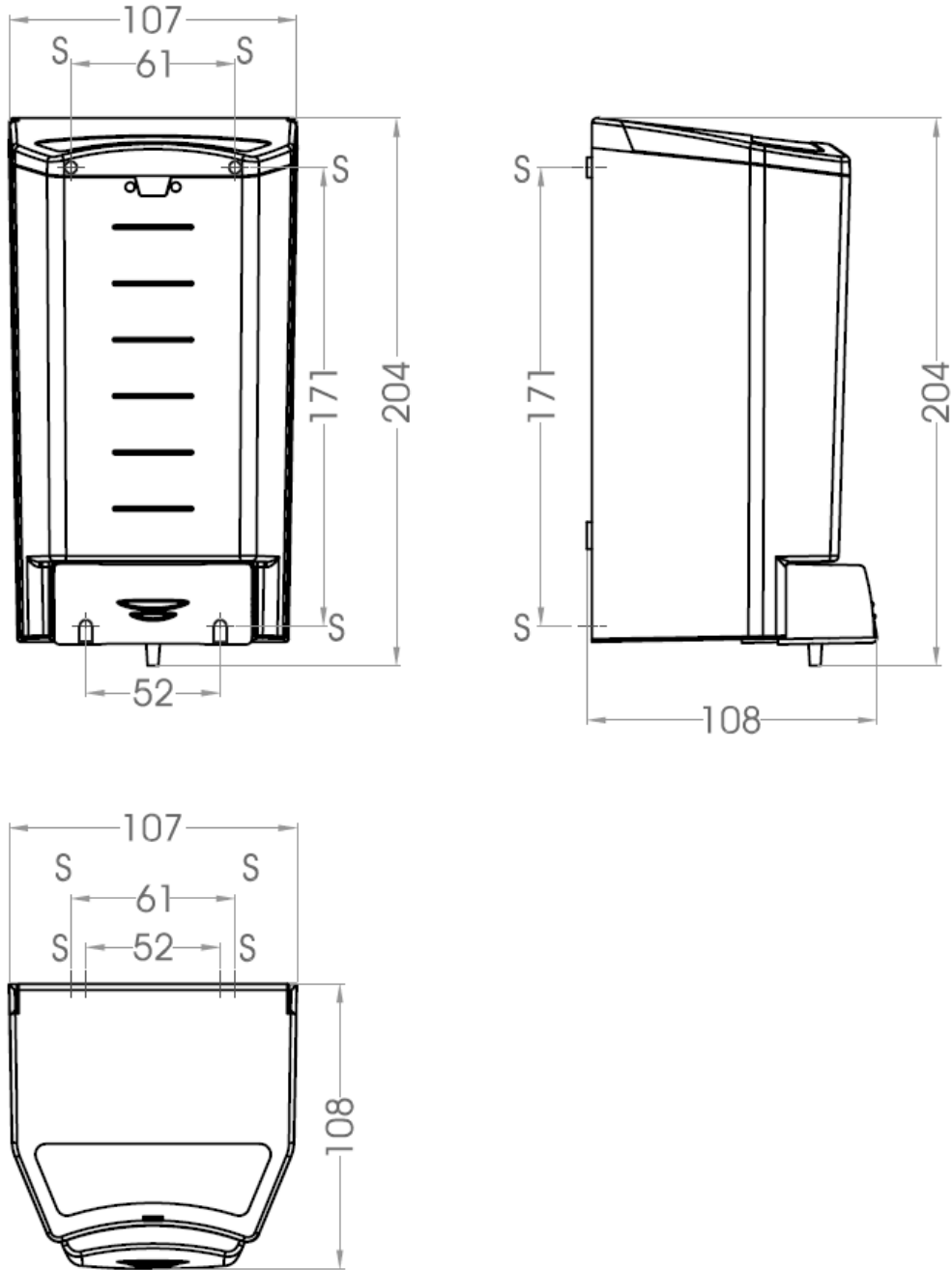

Mediclinics, S.A., reserves the right to make changes and/or modifications to the products and their specifications without prior notice.
Review 01-21 © mediclinics. S.A

